

# INNOVA

CONTROLS



## INSTRUCTIONS MANUAL

# Table of Contents

1. Introduction of the Innova Controls .....	3
1.1 Precautions .....	3
2. Direction of Use .....	4
2.1 Turning on the Control Unit .....	4
2.2 Switching the Heater or Steamer On .....	5
2.2.1 Temperature .....	6
2.2.2 Relative Humidity .....	6
2.2.3 Session Time .....	7
2.2.4 Fan .....	7
2.2.5 Sauna Session .....	7
2.2.6 Steamer Session .....	7
2.3 Switching the Control Unit On/Off .....	8
2.3.1 Cabin Light .....	8
2.4 Pre-run Timer .....	9
2.4.1 Pre-setting the Sauna Before Using .....	9
2.4.2 Pre-run Timer .....	9
2.4.3 Pre-run Timer for Domestic Saunas .....	9
2.4.4 Pre-run Timer for Public Saunas with Weekly Timer .....	11
2.4.5 Countdown for Pre-heat .....	12
2.4.6 More about Pre-run Timer .....	13
2.5 Changing the Settings .....	14
2.5.1 Configuration Icon .....	14
2.5.2 Time and Date .....	14
2.5.3 Escape .....	14
Technical Diagram .....	15
2.5.4 Software Version Info .....	17
2.5.5 LCD Contrast .....	17
2.6 Other Innova Control Features .....	17
2.6.1 Cabin Light .....	17
2.6.2 Key Lock .....	17
2.6.3 Up & Down Arrow Keys .....	18

2.7 Combi Features .....	18
2.7.1 Steamer .....	18
2.7.2 Humidity & Temperature in Sauna .....	18
2.7.3 Cabin Drying .....	18
2.7.4 Water Refill .....	19
4. Assembly and Installation .....	20
4.1 Control Unit to Heater Connection Diagram .....	20
4.2 Power Controller .....	21
4.3 Contactor Unit .....	21
4.4 Sensors .....	22
4.4.1 Sensor Location with Heaters Mounted on the Wall .....	22
4.4.2 Sensor Location with Heaters Mounted on the Floor .....	23
4.5 Maximum Session Time .....	23
4.6 Door Sensor (Optional) .....	24
4.7 Fan (Optional) .....	24
4.8 Dimmer (Optional) .....	24
4.9 Installation for Power Controller with Built-in Control Panel .....	24
4.10 Installation for Separate Control Panel .....	25
4.11 The Control Unit Main Switch .....	25
5. Troubleshooting .....	26
6. Symbol Reference .....	28

# 1. Introduction of the Innova Controls

Congratulations on your purchase of Innova Control Unit!

Innova Control Unit is developed to enhance your sauna bathing with a variety of features. It can adjust temperature, humidity, ventilation and light option in your sauna. The Innova Control Units are available on a separate or built-in mounting on the Power Controller Board.

The following information provides you with instructions on adjusting the settings of the control unit. Please, read this instruction manual carefully before using the control unit. Familiarization of the key functions will give you a more enjoyable sauna experience.



## 1.1 Precautions

1. Only a qualified electrician is allowed to make the electrical connections and repairs on the unit. Use original parts only.
2. Disconnect the Power Controller and the Contactor Unit from the electrical circuit before installation, opening the lid of the power controller or contactor unit and repair.
3. Check power supply rating before installation.
4. Check the correct location of the sensor in the installation section of the manual. It is very important to place the temperature sensor correctly as it closeness of the air ventilation cools down the sensor and may lead to overheating.
5. The control unit can be operated on a room temperature 0-40°C. Do not install the control unit inside the sauna room!
6. Do not pour water in the control unit or clean it with wet cloth. For cleaning purposes, use a cleaning cloth that has been only slightly moistened with a mild soapy solvent (dish detergent).

## 2. Direction of Use

### 2.1 Turning on the Control Unit

\* For illustration purposes only.



When the control unit is in "Off" mode and on/off button is pressed, it will automatically switch on the power. The SAWO logo is displayed for 2 seconds.

Then, the control unit will go to standby menu, where you can switch the heater or steamer on or change any of the settings.



## 2.2 Switching the Heater or Steamer \*ON

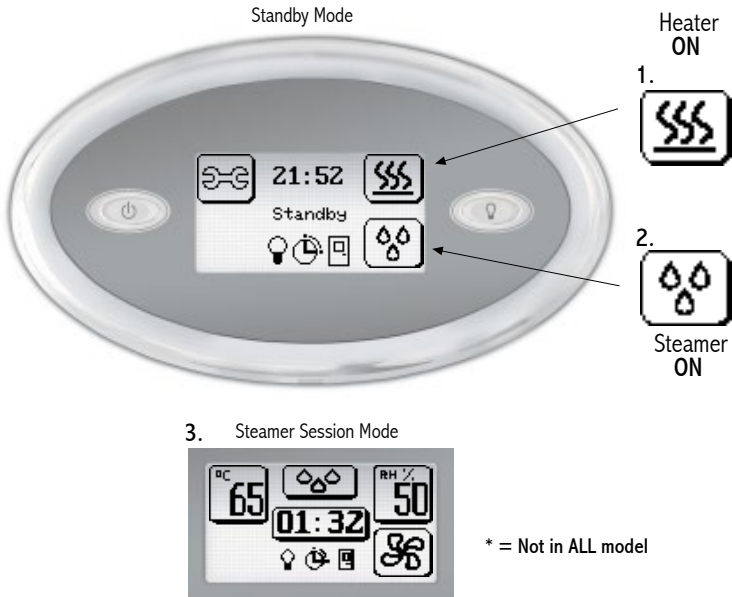

1. The heater can be switched on by pressing the heater icon in standby mode.

2. Alternatively, the user can switch the steamer on by pressing the steamer icon in the standby mode.

3. Then the actual sauna temperature and humidity will be displayed.

4. Turn the heater or steamer off by pressing ON / OFF button on the left side of the screen. The display will return to standby mode.

When the heater (or steamer) is switched on, the set sauna room temperature and the set humidity (only with combined temperature/humidity sensor) or set steamer duty-cycle (only with Combi heater) are shown blinking in the display for 3 seconds.



WARNING

Always check that there are no combustible materials, like towels, above the heater, nor inside the safety distances, before switching the heater on! The safety distances are stated in the heater manual.

Once the heater (or the steamer) has been switched on, "Session" mode will be displayed. The user can change the settings simply by pressing the relevant icon on the display and using the up and down arrows.

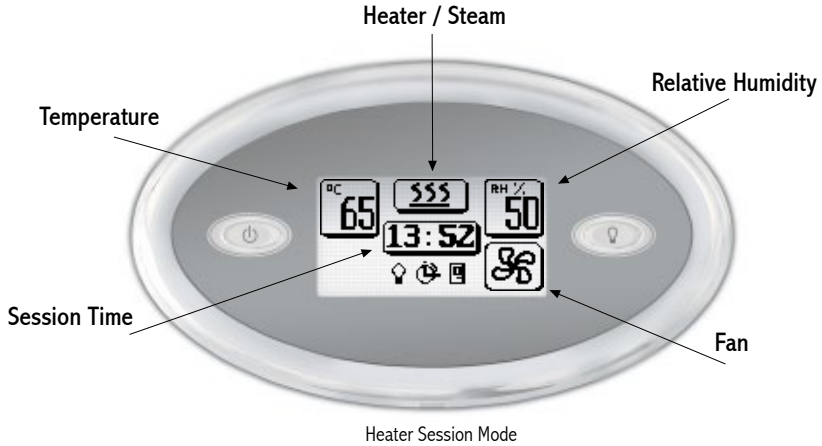

### 2.2.1 Temperature

Press the temperature icon to change the temperature with up and down arrow keys. After setting the preferred temperature, user can go back to the previous menu with saved settings by pressing the enter button.

If no keys are pressed within 5 seconds after pressing the temperature button, the actual temperature in the sauna room is displayed again and changes are discarded.

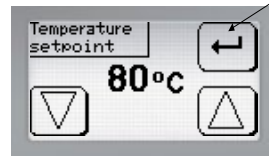

### 2.2.2 Relative Humidity

To change the relative humidity (not in all models), press the humidity icon and use the up and down arrow keys to change it. After setting the preferred humidity, user can go back to the previous menu with saved settings by pressing the enter button.

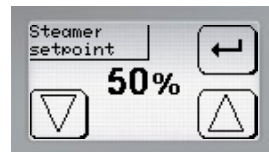

If no keys are pressed within 5 seconds after pressing the temperature button, the actual humidity in the sauna room is displayed again and changes are discarded.

**01:32**

### 2.2.3 Session Time

Press the session time icon to change it with up and down arrow keys. After setting the preferred session time, user can go back to the previous menu with saved settings by pressing the enter button.

If no keys are pressed within 5 seconds after pressing the session time button, remaining session time is displayed again and changes are discarded.

If the session time is changed within the first 5 minutes after starting, the set values are saved as a start value for the next session.

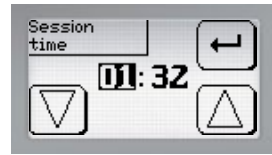

When the session time expires, a high tone buzzer notifies the user. Then the control unit goes to “Standby” mode or cabin drying (only with steamer).

The session can be finished earlier than originally set by pressing the on/off button.

The control unit goes to “Standby” mode or cabin drying (only with steamer).

If the user attempts to put an invalid input, short, low tone buzzer can be heard to alarm the user.



### 2.2.4 Fan

Press the fan icon (not in all models), to set the fan speed, in the range of 5% - 100%. After setting the preferred speed, user can go back to the previous menu with saved settings by waiting for 3 seconds to automatically return or pressing the enter button to return immediately.

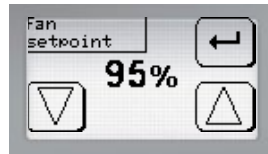

When the fan is on, fan on icon will be displayed.

When the fan on icon is pressed again, it will switch the fan off and the fan off icon will be displayed.



### 2.2.5 Sauna Session

When a sauna session is activated, the sauna symbol is displayed. If user presses the sauna icon, the sauna session will change to steamer session (only with Combi

heater). The sauna icon will consequently switch to steamer icon.

If user does not have a combi heater but the symbol is pressed there will be no activity.



### 2.2.6 Steamer Session

When a steamer session is activated, the steamer symbol is displayed (only with Combi heater). If user presses the steamer

icon, the steamer session will change to sauna session. The steamer icon will consequently change to sauna icon.





## 2.3 Switching the Control Unit ON/OFF

Standby Mode

Power "ON / OFF"

Cabin light "ON / OFF"



**Switch OFF**

In order to switch the control unit Off, the control unit must be in the "Standby" mode! When On/Off button is pressed in another mode, control unit goes to Standby mode.

The on/off button needs to be pressed shortly, less than 3 seconds, to switch the unit on or off.



NOTE

When the control unit is switched off, the timer will not be activated. However, all the set values will remain in the memory. Leave the control unit in the "Standby" mode if the timer is wished to be used!



### 2.3.1 Cabin Light

Cabin lights can be switched on and off by pressing Cabin Light button even when the control unit is off.

If Power on/off button is pressed while the lights are on in the cabin "Cabin lights on" text will be displayed. Press Cabin Light button to switch the lights off and to turn off the control unit.

When cabin lights are on light bulb icon is displayed



## 2.4 Pre-run Timer

Standby Mode



### 2.4.1 Pre-setting the sauna before use



Press the configuration icon in the “Standby” Mode to go to the “Configuration” Mode. Then press the Pre-run Timer icon to switch on the timer.

Configuration Mode

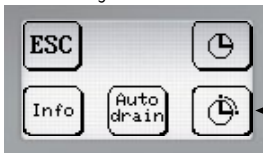

Pre-run  
Timer



Before using Pre-run timer, make sure that the time and date of the control unit are correct. See Changing The Settings / Time and Date.



### 2.4.2 Pre-run Timer

The Innova Touch control unit has a weekly timer that can be programmed for every day of the week. This feature is only available for public saunas, used in condominiums, hotels or other similar places.



By Default, the Pre-run Timer is set for Domestic Sauna use.

### 2.4.3 Pre-run Timer for Domestic Saunas

For domestic sauna use, the weekly timer is not allowed\*). Only one pre-heat timer setting can be made at a time. The pre-run time is limited to a maximum of 5 hours for domestic saunas.

\*) IEC 60335-2-53

After pressing the timer icon in the “Configuration” mode, the following display will be shown displaying existing pre-run settings.

Timer Mode - Off State

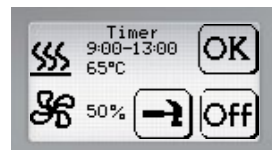

WARNING

Always check that there are no combustible materials, like towels, above the heater, nor inside the safety distances, before switching the heater or pre-run timer on! The safety distances are stated in the heater manual.



The hammer icon is used for changing the settings.

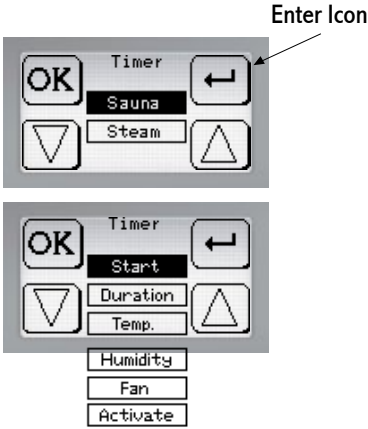

If any pre-run setting needs to be changed push of the hammer icon opens up the settings display (see the picture). Chose the feature using arrow icons and press then enter to open up the setting display for that feature. Change parameters with arrow icons and confirm by pressing enter.

Choosing the Activate icon and then Enter, Pre-run will activate with set values.



NOTE

The start time means the time the sauna is ready to use, therefore the heater is switched on before the set start time. When the heater is switched on the countdown time for the start time will be displayed.



NOTE

Please note that the start time needs to be set before the duration.



When the OK icon is pressed, the unit will go back to the "Standby" mode.

If the Timer was set to "ON" mode, the "Standby" mode will display the symbol for timer.

Timer Mode - On State

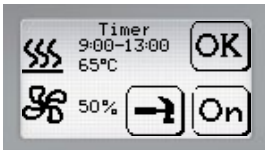

In the "Timer" mode, the user can double-check all the functions and set values.

If the ON icon is displayed, it means the pre-run time is activated for the set values shown in the display. If the ON icon is pressed, it will switch to OFF, inactivating the pre-run timer. The set values will be stored for the next session.

If the OFF icon is pressed, the control unit will activate the timer and display the corresponding ON icon.

Standby Mode with Pre-run Timer symbol



Pre-run timer activated

## 2.4.4 Pre-run Timer for Public Saunas with Weekly Timer

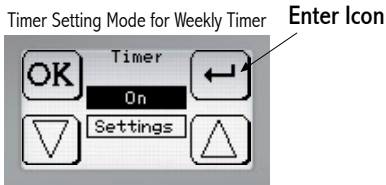

If "Off" is displayed weekly timer is not activated. Pressing Enter icon when off icon is chosen activates the timer and "On" is then displayed. Likewise push of Enter icon when "On" is chosen will inactivate the timer and "Off" will be displayed.

After pressing the timer icon in the "Configuration" mode, user can see the following display for the weekly timer.

**NOTE** To activate the timer weekly preset values must be set (see Settings chapter below for details).



To return to Configuration mode display press OK icon.

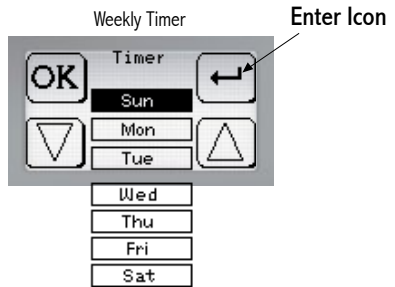

The values for the weekly timer can be set in timer mode. Press "Enter" icon when the Settings is selected.

Choose the day which settings will be set or changed using arrow icons and press Enter.



The hammer icon is used for changing the settings.

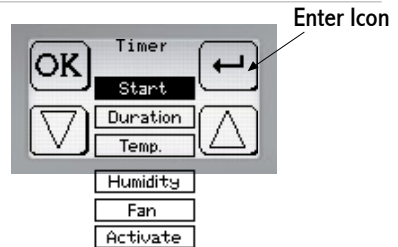

In "Timer" mode push of hammer icon open up settings display (see the picture). Choose the feature using arrow icons and press then enter to open up the setting display for that feature. Change parameters with arrow icons and confirm by pressing enter.



Choosing the Activate icon and then Enter, Pre-run will activate with set values.

OK icon will return the display to standby mode.

#### Timer Mode - On State

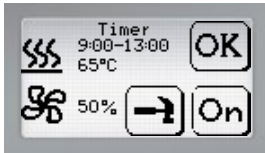

The start time needs to be set before the duration.

In the “Timer” mode, the user can double-check all the functions and set values.



If the ON icon is displayed, it means the pre-run time is activated for the set values shown in the display. If the ON icon is pressed, it will switch to OFF, inactivating the pre-run timer. The set values will be stored for the next session.

When the OK icon is pressed, the unit will go back to the “Standby” mode.

If the Timer is activated, the “Standby” mode will display the symbol for timer.

If the OFF icon is pressed, the control unit will activate the timer and display the corresponding on icon.

#### 2.4.5 Countdown for Pre-heat

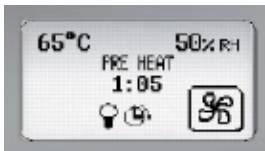

When the control unit is switched Off, the timer will not be activated. However, all the set values will remain in the memory. Leave the control unit in the “Standby” mode if the timer is wished to be used!

When the control unit turns the heater on upon pre-set time, pre-heat countdown mode will be displayed. Once the set Pre-heat time has finished, high tone can be heard and backlight in the display will be switched on to mark sauna is ready for use. Unit will go to Heater / Steamer On mode.

During Pre-heat mode, the heater is turned On.

## 2.4.6 More about Pre-run Timer

When the pre-run function is used for the first time, it estimates the time that the heater needs to reach the set temperature in the sauna room. For example, if the pre-run time is set to 2 hours, the heater will be switched on in 1.5 hours.

If the sauna has not reached the set temperature by the pre-set time, in this case in 30 minutes, control unit will remember that. Next time the pre-run function is used, the heater will be switched on earlier, for example 50 minutes before the end of the pre-run time.

Alternatively, if the heater reaches the set temperature too quickly, it will adjust itself to be switched on later. The control unit teaches itself to switch the heater on at the ideal time in order to reach the set temperature when wanted.

When the pre-run time has expired, there will be a high tone for 5 seconds to notify the user that sauna is ready for use.

Pre-run or Pre-heat can be canceled by pressing Power on/off button. The control unit will go to “Standby” mode and the heater will not be activated.

During Pre-heat and Sauna/Steam Session, opening the door is allowed and timer stays active.



NOTE

If door switch is connected, and door is opened when timer is activated, timer will be deactivated.



## 2.5 Changing the Settings



### 2.5.1 Configuration Icon



The settings for the control unit can be changed in the “Configuration” mode. When the configuration icon is pressed in "Standby" mode, "Configuration" mode will be displayed.

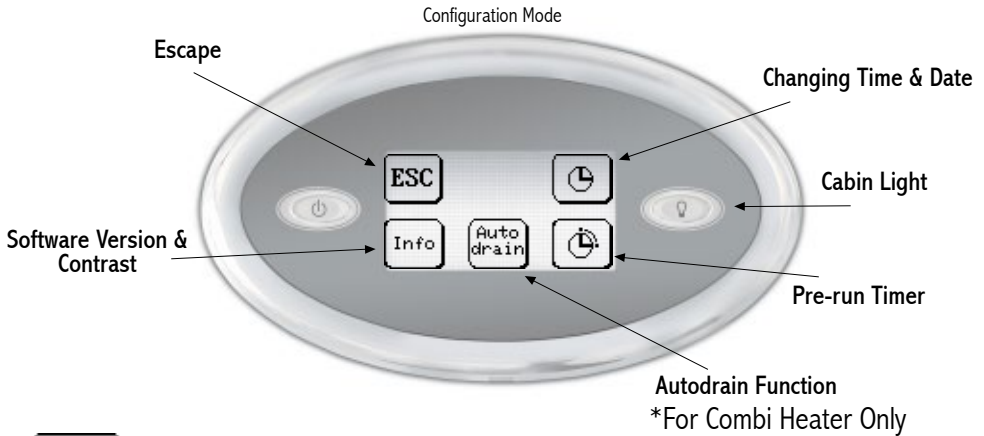

### 2.5.2 Time and Date

Press the top right-hand clock to set the time and date. Use the arrow keys to change the parameters and confirm with the Enter button. Return to the “Configuration” mode by pressing ESC icon.



Enter Icon



### 2.5.3 Escape

Press the ESC button to go back to “Standby” mode.

# Technical Diagram

Fig. 1

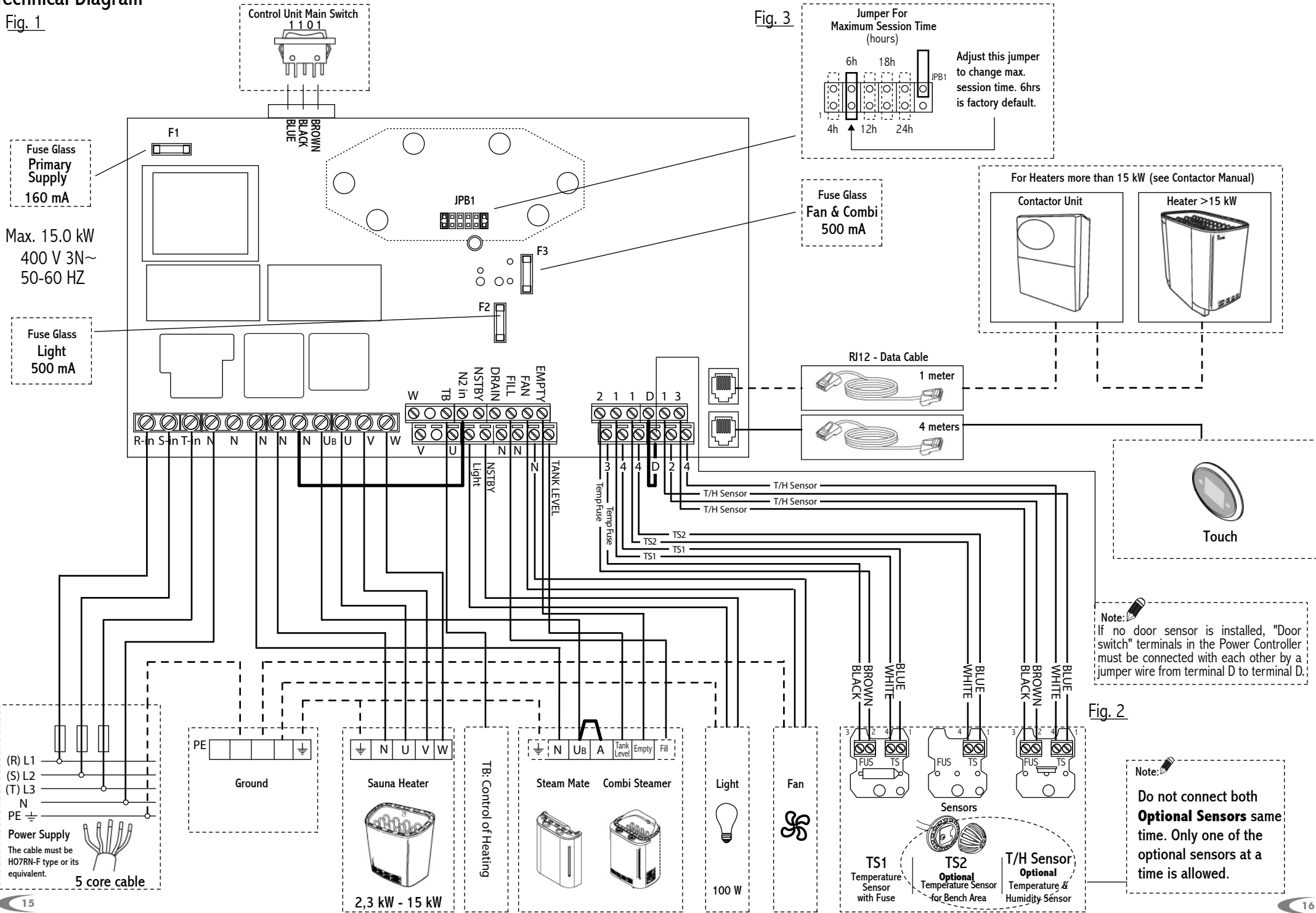
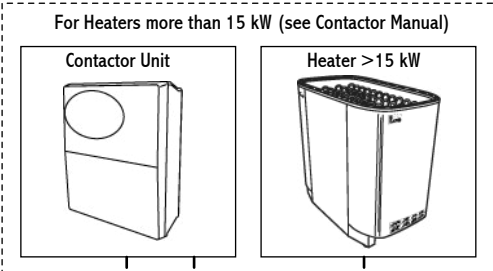
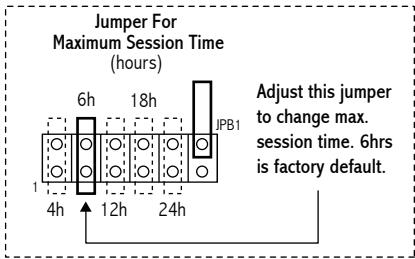
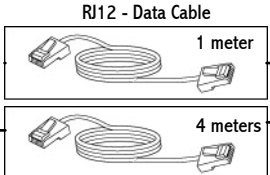

Fig. 3



Fuse Glass Fan & Combi 500 mA



Note: If no door sensor is installed, "Door switch" terminals in the Power Controller must be connected with each other by a jumper wire from terminal D to terminal D.

Fig. 2

Note: Do not connect both **Optional Sensors** same time. Only one of the optional sensors at a time is allowed.

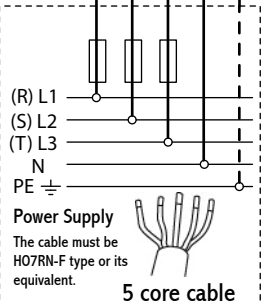





## 2.5.4 Software Version Info

Pressing Info icon software versions will be displayed and the text “Steamer” (only if the steamer is present and activated).

Two software versions are displayed, first one is for the user interface and the second one for the control board.

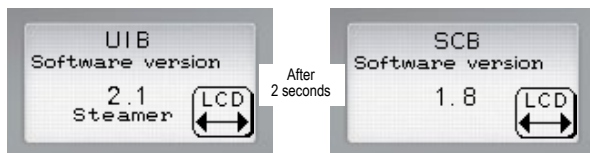

## 2.5.5 LCD Contrast

The LCD contrast can also be set in the “Info” sub-state by pressing the LCD button and using the up and down arrow keys.

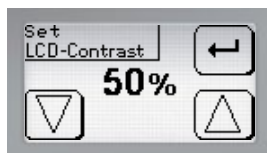

## 2.6 Other Innova Control Features



### 2.6.1 Cabin Light

When cabin light is On, a small light icon is displayed in Standby mode.

If the dimmer option is not present, pressing the cabin light button will switch the cabin light on / off.

With the dimmer option a short push of the cabin light button will turn the lights on and off.

If the cabin light button is pressed for long or when the cabin light is already on, cabin light intensity will be displayed for 5 seconds. Cabin light brightness can be increased / decreased with up / down arrow keys. After 5 seconds of inactivity, the previous display is shown and changes saved. Alternatively press the enter button to save setting and return.



### 2.6.2 Key Lock

The keypad lock can be activated and deactivated in the “Standby” mode by holding down the configuration button for 10 seconds or more. Activation or deactivation is confirmed by a high beep and “Lock ON” or “Lock OFF” message in the display.

When key lock is activated only heater on/off and cabin light functions can be used. If other buttons are pressed, display will show “KEY LOCK” for 5 seconds.

When the control unit is switched on, the key lock will be reactivated automatically if it was activated during the previous session.



### 2.6.3 Up and Down Arrow Keys

The Up and Down Arrow Keys are repetitive. This means that holding down the up or down key will cause the set-point value to increase or decrease with a specific rate. This rate also increases when holding the key for a longer time.

## 2.7 Combi Features

### 2.7.1 Steamer

These features for steamer are only applicable with Combi heaters.

### 2.7.2 Humidity & Temperature in the Sauna

High humidity and high temperature are not allowed simultaneously in the sauna room. When sauna session is switched to steamer session, sensors check that the temperature or the relative humidity inside the sauna room is not too high.

If the temperature or relative humidity is too high, “Hot” will be displayed in the control unit and the steamer will not be activated.

The assessment for “Hot” depends on the second sensor, the bench sensor. If it is a temperature sensor only, and the bench

temperature in the sauna room is 56°C or more, the steamer cannot be activated. The user can choose the relative time for the steamer to be on, within 30-100% of the session time.

However, if the second sensor is combined temperature / humidity sensor, the maximum bench temperature for the steamer to activate is 80°C, as long as the relative humidity in the sauna room is not too high. With the combined sensor, the user can choose the relative humidity inside the sauna room.

### 2.7.3 Cabin Drying

The standard drying time is set for 30 minutes at 70°C. If the fan is connected with the control unit, it will be running at 100%, during the cabin drying. The cabin drying is set to begin 10 minutes after the steamer session. Therefore, the total drying time is 40 minutes.



If during the steamer session the operation mode is changed to heater only, there will be no drying time at the end of the session.

## 2.7.4 Water Refill



When the water level is low, a low tone interval beep and “Fill” will be displayed to alarm the user. The steam level symbol will be blinking each second.

The water tank can be filled manually or automatically (autofill) depending on the steamer model.

The auto Combi heater has a solenoid valve, which will automatically react to the low level of water. The water inlet will open to fill up the tank and steamer session can be continued without intervention.

In the manual fill, the alarm beeps and “Fill” will be displayed as long as the user fills the tank. If the water tank dries, a high tone interval beep and “Dry” display will alarm the user. In the display “Dry” and “Fill” will be alternating each second.



The steamer will automatically be switched off now, only the heater will be working.

Always check that the water supply is open before using the automatic refill Combi heater!

## 4. Assembly and Installation

The Innova Control Unit consists of the Innova Control panel (Separate or Built-in), Power Controller and Sensors. The control panel and Power Controller communicate by using a RJ12 cable.

### 4.1 Control Unit to Heater Connection Diagram

Fig.4

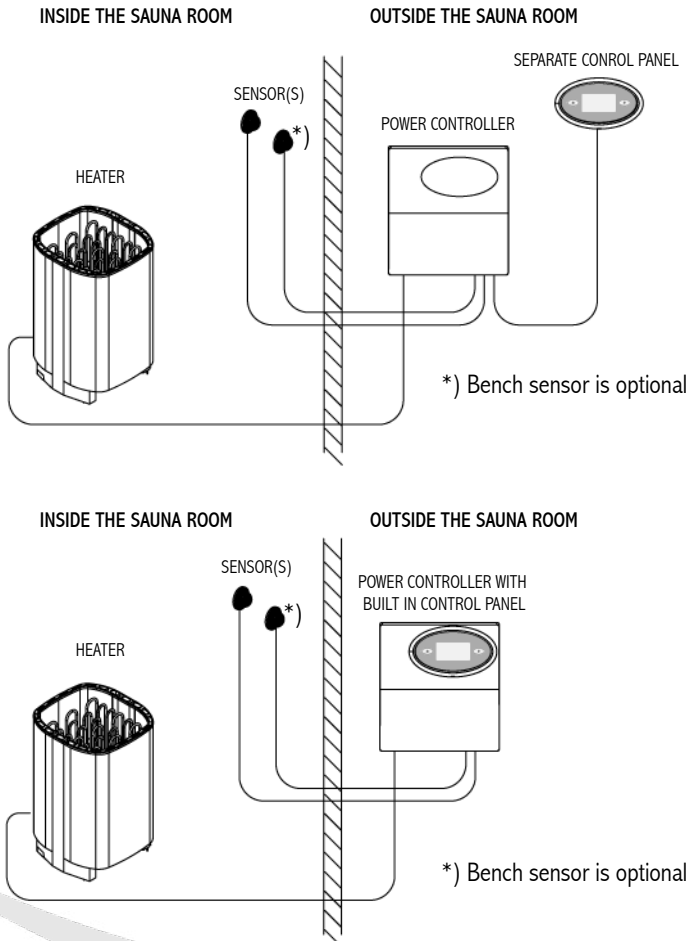

## 4.2 Power Controller

The power controller or the separate control panel must not be located inside the sauna room or in places where temperature can exceed +40°C. It is protected against water splashes, however it should not get in contact with water. Mount the controller board on a dry location, outside the sauna room.

Install the Power Controller Board on the wall in vertical direction only and at least 30cm from the ceiling (refer to Fig.5).

The heater is connected to the electrical network semi-stationarily with a H07RN-F rubber cable or its equivalent. The use of PVC-insulated cable as a connecting cable is prohibited due to thermal embrittlement. The maximum distance of the junction box from the floor is 400 mm, measured from the upper corner of the box.

Fig.5

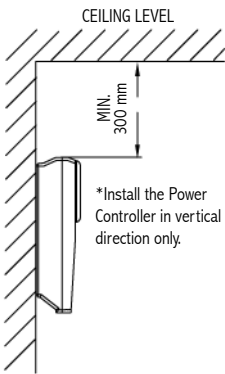
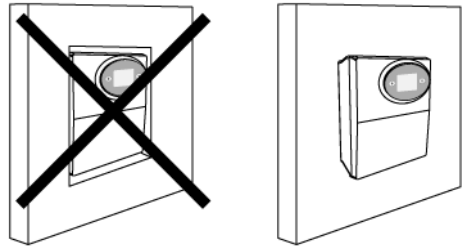

Fig.6



Do not embed the control unit into the wall, because it may lead to overheating of the unit and cause damage!

## 4.3 Contactor Unit

If the heater used is more than 15kW, an additional contactor is needed. The contactor unit is linked to the main Power Controller Board with a RJ12 cable (Fig.7).

Follow the instructions that are supplied together with the contractor unit.

Fig.7

### Installation of separate Control Panel and Power Controller with Contactor Unit

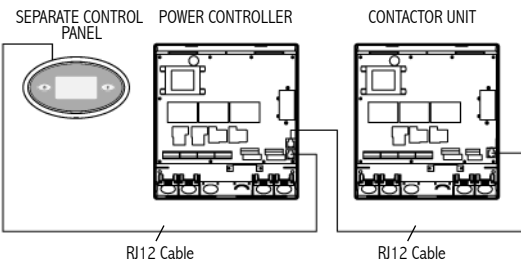

### Installation of Power Controller with built-in Control Panel with Contactor Unit

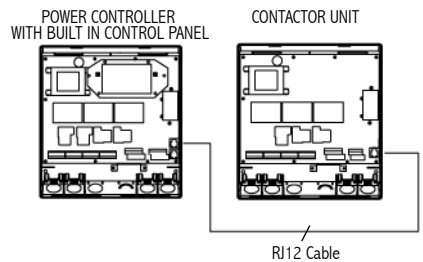

## 4.4 Sensors

One or two sensors can be connected to the Power Controller. The first sensor measures the temperature, it is the sensor with temperature fuse and thermistor.

The second sensor, the optional bench sensor, is a temperature sensor or combined temperature humidity sensor. The combined sensor is capable of measuring the humidity as well as the temperature.

With two sensors it is possible to receive more accurate measurements from the sauna room.

If the heater is mounted on the wall or floor standing less than 200mm from the wall, the first temperature sensor needs to be mounted on the wall above the heater. Place the sensor 150mm from the ceiling (Fig. 8 & 9).

However, if the heater is more than 200mm from the wall, place the sensor to the ceiling, over the heater, as shown in the figure 10 & 11.

The optional second sensor should be mounted on the wall, opposite to the heater, minimum 30cm from the ceiling and minimum 130cm from the floor (fig 8 & 10 ). It is designed to measure the bench temperature, so ideally place it close to the shoulder height of the sauna goers.

Do not place the sensors near the air ventilation. The closeness of the air vent cools down the sensor. Thus, an incorrect temperature is displayed and the heater may overheat (Fig.11).



NOTE

Do not place the sensors too near to air ventilation (not under 1000mm) or not under 500mm from air ventilation, which is directed away from sensors.

### 4.4.1 Sensor location with heaters mounted on the wall

Fig.8

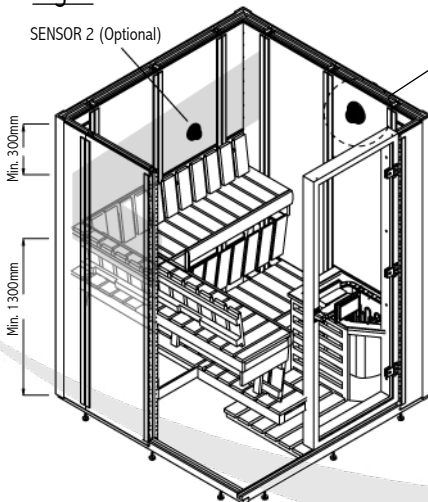

TEMPERATURE SENSOR WITH FUSE

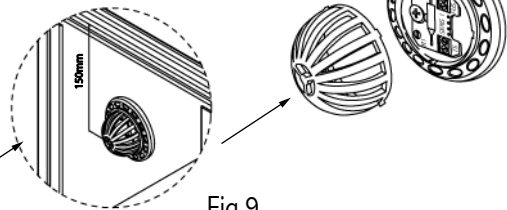
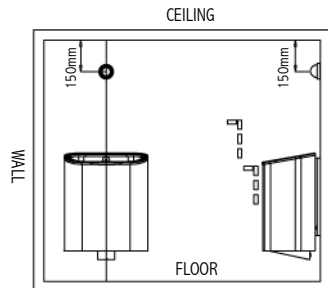

Fig.9



#### 4.4.2 Sensor location with heaters mounted on the floor more than 200mm from the wall

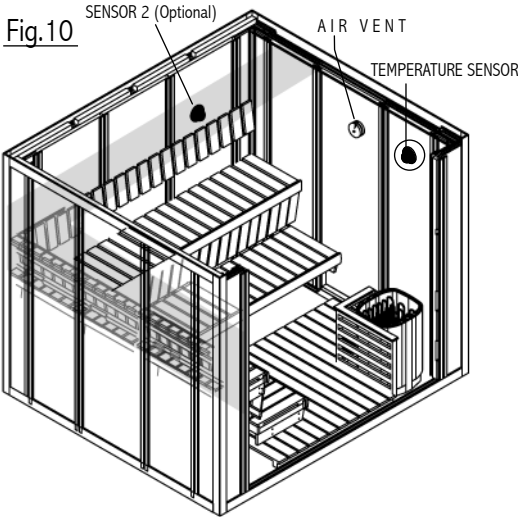
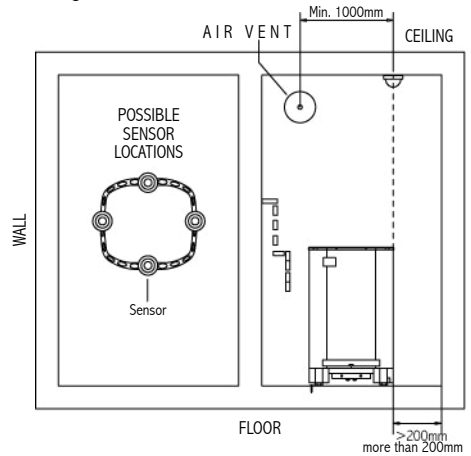

Fig.11



#### 4.5 Maximum Session Time

The maximum sauna session time depends on the purpose of the sauna. For domestic use, the total on-time of the sauna is limited to 6 hours. It includes pre-run time and the session time. The factory setting for the control unit is 6 hours.

For condominiums, hotels and similar locations, the operating period of the sauna heater is limited to 12 hours, including the pre-run time and the session time.

For public sauna, the operating period of the sauna heater can be either 18 or 24 hours. Please note, if the public sauna is set to 24 hours, it will be on constantly. It needs to be continuously attended.

The weekly timer is only allowed for hotels, condominiums and other public saunas. If the

maximum session time is set to 12 hours and weekly timer is used, the heater must have a minimum 6 hours of inactivity in between sessions (IEC 60335-2-53).

The maximum heater on-time is set by the jumpers on SCB1 in the power controller, see the picture 3. In Finland jumpers 3, 4 and 5 are meant only for public sauna rooms. Only a qualified electrical can change the settings. The standards and regulations of the country where the control unit is installed must be followed, when setting the jumpers. When no jumpers are placed, the default time is 6 hours. See the Table 1.

**NOTE** If you need to change the settings in the power controller with built-in panel, removing the panel board helps.

Table 1

Sauna Type	Domestic sauna		Hotels, Condominiums	Public sauna	
Jumper	1	2	3	4	5
Max. time	4h	6h	12h	18h	24h
Max. pre-run time	2h - steam 3h - steam	4h - steam 5h - steam	weekly timer		

## 4.6 Door Sensor (Optional)

In other than household use, it is recommended to install door sensor. The door sensor disables all pre-run operations if the door is opened while the pre-run count-down is active.

The door sensor also ensures that the door is not open for long periods of time when the heater is on. If the heater is on and the door is open for more than 15 minutes, an alarm and "DOOR" will be displayed to warn the user. The heater will be switched off automatically.



If no door sensor is installed, "Door switch" terminals in the power controller board must be connected with each other by a jumper wire. See fig. 2, note: connection is not present in the drawing.

## 4.9 Installation for power controller with built in control panel (See Illustration)

Follow the steps in the illustration below. Before installation, please read first chapter 1.1 Precautions.

1. Install Power Controller outside sauna room in a dry place, where temperature will not exceed +40C and condense of water is not possible inside the controller.
2. Unscrew two screws from the top cover.
3. Remove the plastic cover of the unit by pushing the front lock through the hole in the chassis.
4. Insert the designated wires to corresponding terminals. See Diagram.
5. Drill holes for the screws on the wall to attach the power controller. Install the power controller in vertical direction only. Follow the measurements given.
6. Cover back the power controller after the wiring connections have been made by snapping the front lock. Screw the two screws back to the top cover.

Fig.12

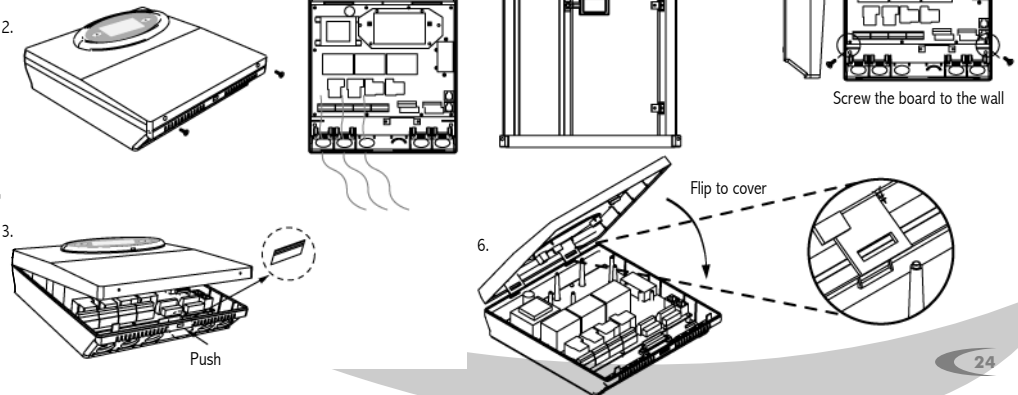

## 4.7 Fan (Optional)

The fan function can only be activated if the fan feature is present on the control unit. Ensure that the fan motor to be controlled is either shaded pole or permanent split capacitor motor. The maximum power is 100W with 230 VAC.

## 4.8 Dimmer (Optional)

It is possible to use any suitable lamp of your choice in the sauna room. However, if the dimmer feature is present on the control unit and wished to be used, only incandescent lamp is suitable.



## 4.10 Installation for Separate Control Panel (See Illustration)

1. Mount the Separate control panel casing outside the sauna room, in preferred, secure area on a room temperature.
2. Cut the wall section according to the specifications.
3. Connect the RJ12 cable provided from the control panel to the Power Controller.
4. Insert the casing on the cut section.
5. Screw the Control panel to the wall on the holes provided.
6. Snap the top cover of the panel to its place.

Fig.13

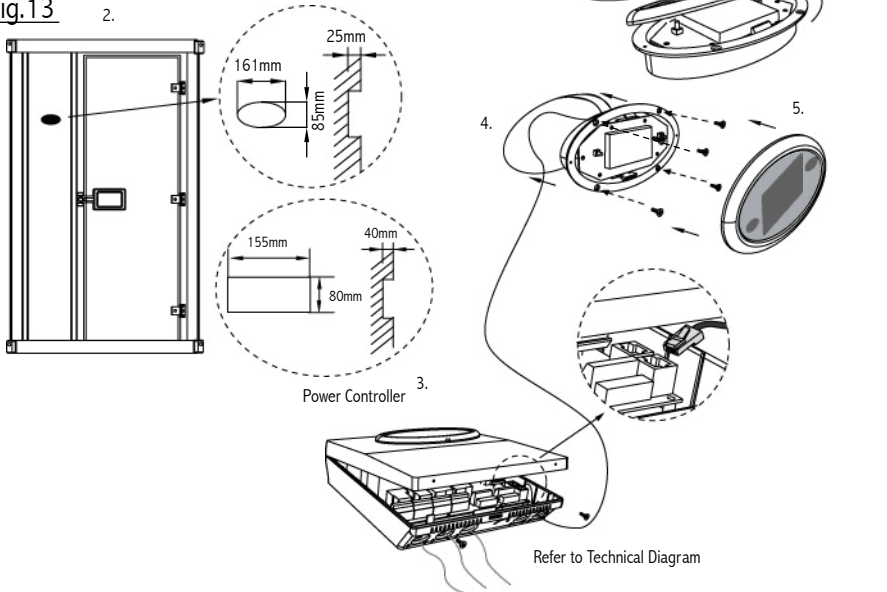

## 4.11 The Control Unit Main Switch

The control unit switch can be found on the top end of the unit. Using this switch, you can isolate the electronics from the mains power supply.

In order to put the unit into operation, switch to the first position (switch position I). In this switch position all control unit's functions work normally.

In case of breakdown, press the control unit switch on the left part of the rocker to the middle position (switch position 0). The unit is now completely switched off.

In order to switch on the light in the sauna when the unit is switched off, press on the left part of the rocker to the second position (switch position II).

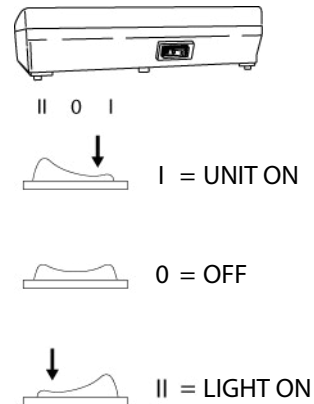

## 5. Troubleshooting

If an error occurs, the heater will be switched off. There will be a high tone warning beep for 2 seconds. Text “ERROR” will be blinking in the display with the error description. See more details on the table below.



Please note, only a qualified electrical or maintenance personnel should make the service operations or repairs.

Table 2

Code	Problem	Solution
E1	Temperature sensor 1 is not connected.	Check the wire between the sensor and the control unit. If there is no problem with the wires and they are correctly installed, check the sensor. If no reason for the problem can be found, contact the retailer.
E2	Temperature sensor 1 is short circuit.	
E3	Temperature fuse has blown.	Check the wire between the sensor and the control unit. It has probably overheated. The reason for it needs to be discovered before using the sauna again. A new sensor is needed. If no reason for the problem can be found, contact the retailer.
E4	Temperature sensor 2 is not connected.	Check the wire between the sensor and the control unit. If there is no problem with the wires and they are correctly installed, check the sensor. The heater can still be used with the sensor 1 only, but 2 sensors are needed for the steamer. If a new sensor needed or no reason for the problem can be found, contact the retailer.
E5	Temperature sensor 2 is short circuit.	
E6	Combined Temperature / Humidity sensor is defective.	
E7	Communication failure.	
E7	Communication failure.	Check the RJ12 cable.  If the area where the cable is located has many other cables, it can cause interference problems. If built-in model is used, remove the control panel. Wipe the pin header contact to remove any dirt. Assemble back the control panel in correct position and make sure the six pin header connectors are properly inserted to the socket. If no reason for the problem can be found, contact the retailer.
E8	Temperature is greater than the maximum temperature.	Contact qualified electrician or maintenance personnel before using the sauna again.

## Other possible problems are:

- The control unit is working fine, but the heater does not turn on. Check the electricity supply to the heater. Check that the wires for the sensors are placed into the correct terminals in the power controller.
- The control unit cannot display the relative humidity (only when the combined sensor is installed). The combined sensor cannot be recognised. The wires for the sensor are placed in the wrong terminals.
- Control unit does not turn on. Check that:
  - Main switch of control unit is in position 1 (Unit On). Two illuminated dots on display indicate that power is on.
  - N2in is connected with the N with a wire jumper.
  - Fuse F1 (near transformer) is tightly in fuse holder.
- If error E4 or E6 is displayed, there is a problem with the bench sensor. If only one sensor is installed, the steamer cannot be used. The user can confirm the error by pressing the on/off button, after which the heater will function normally, but the steamer cannot be used.
- The user switches the steamer on and “dry” is displayed immediately. Check that the “empty” and “tank level” terminals from the heater are connected with the “empty” and the “tank level” in the power controller.
- The steamer is on and “dry” is displayed, even though there is plenty of water in the tank. Make sure that terminals “empty” and “tank level” are correctly connected to the right terminals in the power controller.
- The steamer is switched on and “dry” is displayed immediately. Make sure that the “WB” terminal from the heater is connected to the “tank level” in the power controller. Check that the “UB” terminal from the controller is connected with the “empty” terminal on the controller.
- When the user turns the steamer on and “Fill” is displayed continuously, the wiring needs to be checked. Make sure that the “UB” terminal from the controller is connected to the “empty” terminal in the power controller. In addition, the “WB” terminal from the heater needs to be connected to the “tank level” in the power controller.
- Door open symbol is displayed with high warning tone, when door sensor is not installed. - Check that door switch terminals are connected with each other by wire in the power controller. (See fig. 2/Sensors. Note that the connections is not present in the drawing

## 6. Symbol Reference

### Keys



On / Off



Steam session



Cabin Light



Configuration



Sauna session

### Indicators



Cabin light on

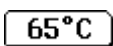

Set temperature



Pre-run timer mode



Remaining time – session,  
pre-run, drying



Cabin door open

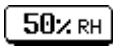

Set relative humidity



Fan off



Go to “Info”



Fan on



Go to previous screen



Timer On



Pre-run Timer



Timer Off



Set time and date



Enter, OK



Change settings



Increase the value



Decrease the value

Description	Power Rating	Remarks
<b>Control</b>		
Rated Power 3 Phases	15kW AC1 (3 x 5kW)	
Rated Voltage 3 Phases	400V 3N~	
Rated Power Single Phase	9kW AC1	
Rated Voltage Single Phase	230V 1N~	
Frequency	50/60Hz	
Switching capacity per phase	21A	
Sauna temperature range	40-110°C	
Maximum session time (preset)	4,6, 12, 18, 24h	Restrictions apply according to IEC/EN 60335-2-53
Dimensions INNOVA S types		
User Interface	(W) 180 x (H) 105 x (D) 31	
Power Controller	(W) 265 x (H) 245 x (D) 75	
Dimensions INNOVA B types	(W) 265 x (H) 245 x (D) 75	
Weight INNOVA S types		
User Interface	120g	
Power Controller	1500g	
Weight INNOVA B types	1600g	
<b>Sensor</b>		
Temperature Sensor with fuse		
<b>Bench Sensors</b>		
Bench Temperature Sensor		Optional
Bench Combined Temperature - Humidity Sensor		Optional

Description	Power Rating	Remarks
<b>Steamer</b>		
Rated Power 3 Phases	5KW AC1	
Rated Power Single Phase	3KW AC1	
Rated Voltage	230V 1N~	
Switching capacity	21A (3 Phases), 13A (1 Phase)	
Maximum sauna temperature for steamer operation	80°C or *55°C * Depending on the type of Sensor 2.	
Automatic water filling		Optional
Automatic drain valve		Optional
<b>Cabin Light</b>		
Rated	230V 1N~, 100W AC1	Min 20W, max 100W. Only resistive load or dimmable (phase control compatible) light bulb
		Dimmer optional
<b>Fan</b>		
Rated	230V 1N~, 0.5A	Fan without starting capacitor. Optional (with speed control)
<b>Fuse</b>		
Fuse F1	(160mA) is fuse for electronics	
Fuse F2	(1A slow) is fuse for cabin light,	
Fuse F3	(500mA slow) is fuse for fan and automatic refilling combi .	
<b>Power Extension Unit</b>		
Rated Power 3 Phases	15kW AC1 (3 x 5kW)	Additional Power expansion to maximum of 30kW
Rated Voltage 3 Phases	400V 3N~	
Frequency	50/60Hz	
Switching capacity per phase	21A	

**Note!**

Only incandescent light bulbs are allowed to use with Innova sauna controller. Light fixtures using electronic transformers for example LED lights, compact fluorescent lights and other similar lights are not compatible with Innova sauna controller. Damages caused by connecting these non-compatible lights are not covered by warranty.



www.sawo.com  
info@sawo.com

Subject to change without notice.

